

# TERMITRAB complete

## Surge protection for signal circuits of the MCR technology

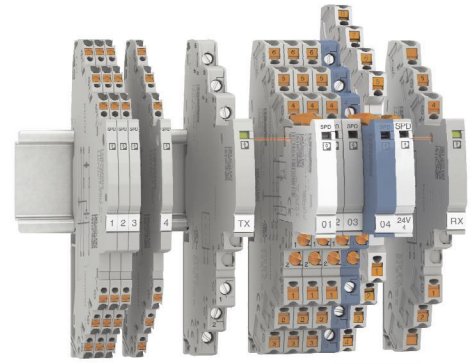

Technical Note  
107820\_en\_06

© PHOENIX CONTACT 2020-05-05

### 1 Description

The TERMITRAB complete product range offers surge protection solutions for signal circuits in measurement and control technology. The protective elements are characterized by their narrow design.

TERMITRAB complete products with status indicator have a protection function. In the event of a thermal overload, the protection function disconnects the components mechanically. If overload protection has been enabled, the surge protective device signals by means of a red indicator. The status indicator operates without additional auxiliary power.

The monitoring function can be integrated into existing remote signaling concepts. Remote signaling modules are available for this. The protective elements are monitored visually. Group remote signaling is triggered. The status is indicated on the faulty device.

Pluggable protective devices and products with disconnect knives facilitate maintenance and testing activities in the system.

You can test all the protective plugs of the two-piece TERMITRAB complete products in detail with the CHECKMASTER 2 test case from Phoenix Contact. The test results can be easily exported as a test report.

TERMITRAB complete is available with screw connection and Push-in connection technology. Further product features round off the surge protection system.



Make sure you always use the latest documentation.

For the technical data, please refer to the relevant product at [phoenixcontact.net/products](https://phoenixcontact.net/products).

---

<b>2</b>	<b>Table of contents</b>	
1	Description .....	1
2	Table of contents .....	2
3	Ordering data .....	3
4	Order key .....	5
5	Versions .....	6
5.1	Pluggability and testing .....	6
5.2	Indirect grounding (floating) .....	6
5.3	Knife disconnection .....	6
5.4	Status indicator and remote signaling set .....	7
5.5	Remote signaling set for intrinsically safe circuits (Ex i) .....	8
5.6	Replacement plug .....	8
5.7	Fuse carrier .....	9
6	Connection and operation .....	10
6.1	Safety notes .....	10
6.2	UL notes .....	10
6.3	Installation and connection .....	12
6.4	Insulation testing .....	13
6.5	Testing option .....	14
6.6	Marking .....	14
6.7	Removal from the DIN rail .....	14

### 3 Ordering data

Description	Type	Order No.	Pcs./Pkt.
-------------	------	-----------	-----------



The current ordering data for the relevant products can be found at [phoenixcontact.net/products](http://phoenixcontact.net/products).

Accessories	Type	Order No.	Pcs./Pkt.
Marker pen without ink cartridge, for manual labeling of markers, labeling extremely wipe-proof, line thickness 0.35 mm (Marking)	X-PEN 0,35	0811228	1
Zack Marker strip, flat, Strip, can be ordered: Strip, white, labeled according to customer specifications, mounting type: snap into flat marker groove, for terminal block width: 6.2 mm, lettering field size: 5.15 x 6.15 mm, Number of individual labels: 10 (Marking)	ZBF 6 CUS	0825027	1
Zack Marker strip, flat, Strip, white, unlabeled, can be labeled with: PLOTMARK, CMS-P1-PLOTTER, mounting type: snap into flat marker groove, for terminal block width: 6.2 mm, lettering field size: 5.15 x 6.15 mm, Number of individual labels: 10 (Marking)	ZBF 6:UNBEDRUCKT	0808710	10
Zack Marker strip, flat, Strip, white, unlabeled, can be labeled with: PLOTMARK, CMS-P1-PLOTTER, mounting type: snap into flat marker groove, for terminal block width: 6.2 mm, lettering field size: 5.15 x 6.15 mm, Number of individual labels: 10 (Marking)	ZBF 6/WH-100:UNBEDRUCKT	0808736	100
Zack Marker strip, flat, Strip, white, labeled, Printed vertically: consecutive numbers 1 ... 10, 11 ... 20, etc. up to 91 ... 100, mounting type: snap into flat marker groove, for terminal block width: 6.2 mm, lettering field size: 5.15 x 6.15 mm, Number of individual labels: 10 (Marking)	ZBF 6,QR:FORTL.ZAHLEN	0808765	10
Quick mounting end clamp for NS 35/7,5 DIN rail or NS 35/15 DIN rail, with marking option, with parking option for FBS...5, FBS...6, KSS 5, KSS 6, width: 5.15 mm, color: gray (Mounting)	CLIPFIX 35-5	3022276	50
Zack Marker strip, flat, Strip, white, unlabeled, can be labeled with: PLOTMARK, CMS-P1-PLOTTER, mounting type: snap into flat marker groove, for terminal block width: 3.5 mm, lettering field size: 3.5 x 5.2 mm, Number of individual labels: 10 (Marking)	ZBF 3,5:UNBEDRUCKT	0829392	10
Zack Marker strip, flat, Strip, white, labeled, printed horizontally: consecutive numbers 1 ... 10, 11 ... 20, etc. up to 91 ... 100, mounting type: snap into flat marker groove, for terminal block width: 3.5 mm, lettering field size: 5.15 x 3.5 mm, Number of individual labels: 10 (Marking)	ZBF 3,5,LGS:FORTL.ZAHLEN	0801406	10
Module set for the optical monitoring and floating remote signaling of neighboring surge protective devices of the TERMITRAB complete product range.	TTC-6-FMRS-UT	2907810	1

Accessories	Type	Order No.	Pcs./Pkt.
Partition plate for NS-35/7,5 DIN rails to ensure a clearance of 50 mm between the remote signaling module and surge protection in TTC-EX systems.	TTC-EX-PP	1011977	10
Shield fast connection for 3 ... 6 mm cable diameter. Potential connecting cable: 200 mm, 1 mm <sup>2</sup> , color: black (Mounting)	SSA 3-6	2839295	10
Shield fast connection for 5 ... 10 mm cable diameter. Potential connecting cable: 200 mm, 1 mm <sup>2</sup> , color: black (Mounting)	SSA 5-10	2839512	10
Fuse carrier for surge protective devices of the TERMITRAB complete product range with screw connection technology. Multi-level connection on TTC-6 housings possible. For conventional 5x20 mm miniature fuses.	TTC-6-FC-UT	1054762	1



The corresponding end cover and the appropriate end brackets can be found in the accessories area for the relevant product at [phoenixcontact.net/products](https://www.phoenixcontact.net/products).

The current range of accessories can be found in the accessories area for the relevant product at [phoenixcontact.net/products](https://www.phoenixcontact.net/products).

## 4 Order key

Order key - with example:

**TTC** - **6** **P** - **1x2** - **F** - **M** - **24DC** - **PT** - **I**  
 | | | | | | | | | |  
 ① ② ③ ④ ⑤ ⑥ ⑦ ⑧ ⑨

### Versions:

- ① = Product family  
**TTC** = TERMITRAB complete
- ② = Housing width  
**3** = 3.5 mm  
**6** = 6 mm
- ③ = Pluggability  
**P** = Pluggable  
       = Not pluggable
- ④ = Protective circuit type  
**1x2** = Two signal wires, floating  
**2x1** = Two signal wires, common reference potential  
**2** = Two signal wires, without decoupling  
**2-HC** = Two signal wires, without decoupling, for high nominal current  
**3-HF** = Two signal wires with reference conductor for high-frequency applications  
**3** = Three signal wires, without decoupling  
**4** = Four signal wires, without decoupling  
**TVSD** = Suppressor diode  
**MOV** = Varistor  
**GDT** = Gas-filled surge arrester  
**C** = One component in core-ground mode  
**D** = One component in core-core mode  
**T3** = IEC class type 3 for protection of the power supply
- ⑤ = Grounding  
**F** = Floating (via GDT)  
       = Direct grounding
- ⑥ = Capabilities  
**M** = Knife disconnection  
**EX** = For explosive areas
- ⑦ = Nominal voltage / application  
 Example:  
**24DC** = 24 V DC  
**TELE** = For telecommunications applications
- ⑧ = Connection method  
**PT** = Push-in Technology  
**UT** = Screw connection
- ⑨ = Signaling  
**I** = Status indicator  
       = Without status display



The latest versions are listed in the product area at [phoenixcontact.net/products](https://www.phoenixcontact.net/products).

## 5 Versions

Combine various circuits and features according to the relevant requirements.

### 5.1 Pluggability and testing

Pluggable and testable products are indicated with the letter "P" in the order key.

Surge protection products are designed for use over a long period of time. When used as intended within the specified parameter ranges, the service life of the products can run into many years. During this time, the surge protection processes a large number of transient overvoltages. The end device is protected effectively.

However, in the event of intensive overload the quality of protection may decrease. By testing, you can determine whether protection is sufficiently effective, or whether protective devices are already impaired. These tests and their documentation are a mandatory requirement in some areas of industry.

TERMITRAB complete offers two-piece, pluggable protective devices. They enable protective plugs to be easily removed from the base element.

The plug can be tested with the CHECKMASTER 2 from Phoenix Contact. To this end, a barcode is printed on the plug. The scanner on the CHECKMASTER 2 automatically identifies the corresponding product when the data is read in. The corresponding template is loaded so that the CHECKMASTER 2 can compare the target and actual parameter ranges of the protective elements.

If the tested plug is no longer within the intended range, replacement is recommended. Replacement plugs are available from Phoenix Contact for such a case.

The order number on the base element is valid for the complete item comprising the base element and plug. The order number for the plug is intended for reordering replacement items.

When plugged in, a snap-in lever prevents the plug from moving even in the event of strong vibrations. A mechanical coding system ensures that only matching plugs and base elements can be connected together.

Insertion and removal is impedance-neutral, which means that signals are not interrupted during maintenance work and testing. The cables connected to the base element remain fixed in the installation.

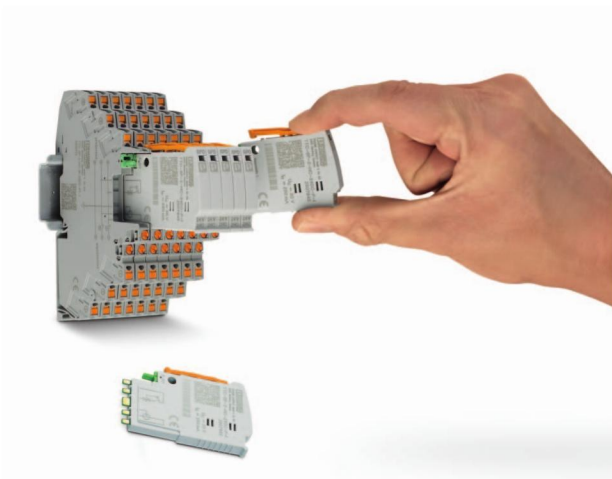

Figure 1 TERMITRAB complete, pluggable

### 5.2 Indirect grounding (floating)

Products with indirect grounding are indicated with the letter "F" in the order key.

In scenarios where direct grounding of the third terminal level (terminal blocks 3 - 6) is not desirable, versions with an additional gas discharge tube for the DIN rail are used.

Example: a common reference potential (common return conductor) is led via the third terminal level, however this must not have a ground connection to the surge protection. An additional gas discharge tube is useful in such a case

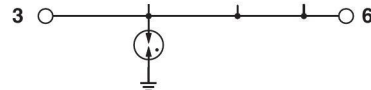

Figure 2 Indirect grounding

### 5.3 Knife disconnection

Products with knife disconnection are indicated with the letter "M" in the order key.

Disconnect terminal blocks are frequently used in sensor/ actuator cabling. These disconnect terminal blocks are installed between the modules for measurement and control technology and the cables led into the field. The disconnect terminal blocks can be used to interrupt signal circuits in order to conduct measurements in the field.

The disconnection option can be used on the top two terminal levels. Isolator 1 opens and closes the signal on the field side directly at terminal point 1. Isolator 2 opens and closes accordingly directly at terminal point 2.

For example, insulation measurements can be carried out on the cables without the surge protection components distorting the test results.

The dielectric strength of the knife disconnection is 2.5 kV (1.2/50  $\mu$ s).

When open (unscrewed), the function screw of the knife disconnection is 7 mm above the upper edge of the housing. In order to minimize contamination of the switching contacts in harsh and dusty ambient conditions, the knife disconnection has an encapsulated design.

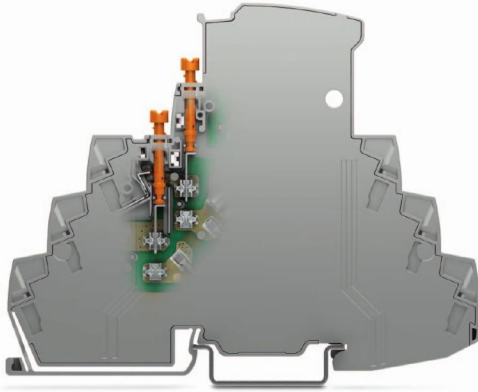

Figure 3 Knife disconnection opened

#### 5.4 Status indicator and remote signaling set

Products with status indicator are indicated with the letter “I” in the order key.

Status indicators and remote signaling are playing an increasingly important role in large technical systems.

As soon as a fine protection element becomes thermally overloaded, the overload protection disconnects the affected component. A mechanical indicator on the device clearly indicates that it has been disconnected. The signal remains unaffected by the disconnection. The dielectric strength of the system is still protected by the coarse protection in the device. Replace the device.

Fault indication in the respective surge protective device does not require a supply voltage.

If you also need the state to be signaled remotely, use the remote signaling set (FMRS) in addition. The set consists of a visual transmission module and receiver module.

The transmitter module should be mounted to the left of the block and the receiver module to the right. Connect each of these modules to a 10 V DC ... 36 V DC supply voltage. A brief system initialization begins as soon as the supply voltage has been connected properly. Initialization is complete when the transmitter and receiver LEDs light up “green”.

The receiver module detects a visual signal that passes through all the surge protective devices. In the event that a fault indicator is triggered, this visual signal is interrupted. The receiver module activates the signal contact after a delay time of 5 seconds has elapsed. This means that brief

interruptions in the optical beam do not cause the annunciator relay to switch.

The function signaling modules independently return to “OK” mode when the faulty surge protection module is replaced.

The relay contact in the receiver module closes as soon as the operating voltage has been applied to the module and the light signal is permanently detected by the transmitter. The contact opens with a delay if a surge protective module is overloaded and the light signal from the receiver does not arrive. If the auxiliary voltage has failed at the remote signaling module, the contact also opens. The relay contact is floating. It is suitable for integration into a superordinate alarm signaling system.

Monitor up to 40 neighboring surge protection products with one remote signaling set.



Figure 4 TERMITRAB complete remote signal set (Push-in version)



The connection schematic can be found in section 6.3, “Mounting and connecting”.

### 5.5 Remote signaling set for intrinsically safe circuits (Ex i)

Combine surge protection modules for intrinsically safe circuits in accordance with IEC 60079-11 with the remote signaling set (FMRS).

Observe the following requirements:

- There must be a distance of at least 50 mm between the terminal points of intrinsically safe and non-intrinsically safe products.
- The terminal points may be separated using an insulating separating plate.

For example, use accessory component TTC-EX-PP (Order No. 1011977) as the separating plate. This separating plate is optimally designed for the housing contour of TERMITRAB complete products and meets the separation conditions.

Exception:

- When installing the TTC-6P-4... (Order No. 1106013, 1106014) with the partition plate TTC-EX-PP, the thread measure is not reached. The thread measure is reached by installing the TTC-6P-4... with a clearance of at least 18 mm to the partition plate.

Install the remote signaling set transmitter and receiver with the separating plates directly at the intrinsically safe products or as a mixed installation (Ex i and non-Ex).

Examples can be found in the following figures.

The remote signaling modules must be installed outside of Ex zones (IEC 60079). If the installation location is inside Ex zones (IEC 60079), appropriate measures must be taken. Intrinsically safe circuits can be led up to zone 0.

We recommend using end brackets at both ends of the installation.

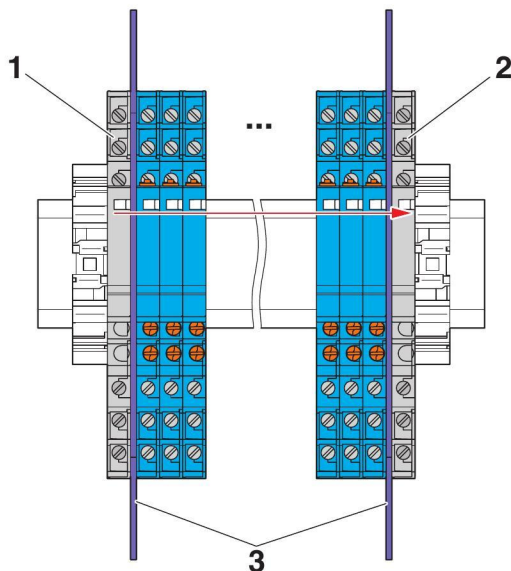

Figure 5 Ex i installation with remote signaling set

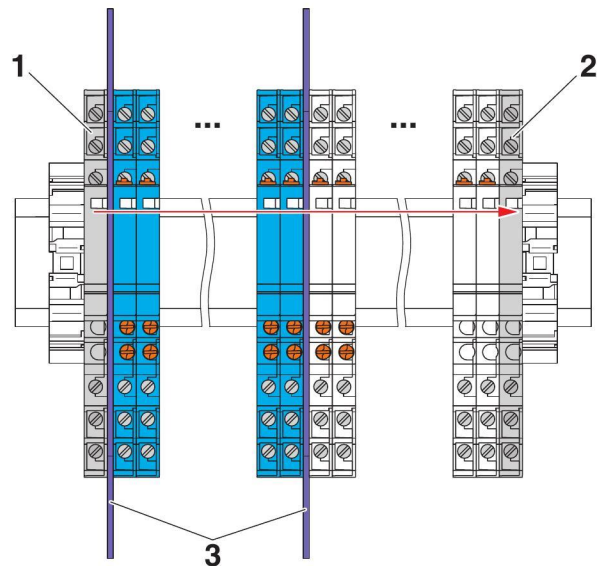

Figure 6 Mixed installation with remote signaling set

- 1 Transmitter module (remote signaling set)
- 2 Receiver module (remote signaling set)
- 3 Partition plate

### 5.6 Replacement plug

Replacement plugs are available for pluggable TERMITRAB complete products.

To facilitate re-ordering, the order number for the replacement plug can be found on the plug.

The appropriate replacement plug is also listed in the product area at [phoenixcontact.net/products](http://phoenixcontact.net/products).



### 5.7 Fuse carrier

Use selective miniature fuses in signal circuits to protect the system components from impermissibly high currents in the event of a fault.

Combine this function with a TERMITRAB complete 6 mm series surge protective module with screw connection. Use the TERMITRAB complete fuse carrier for this purpose.

Use conventional G-5 x 20 mm miniature fuses in the fuse carrier.

- Place the miniature fuse in the cover of the fuse carrier.
- Close the cover. The fuse moves into the holder and contact is established.

You can use one or more fuse carriers for the TERMITRAB complete surge protective module.

- Place the fuse carrier in the lower terminal level.
- Screw on the fuse carrier.

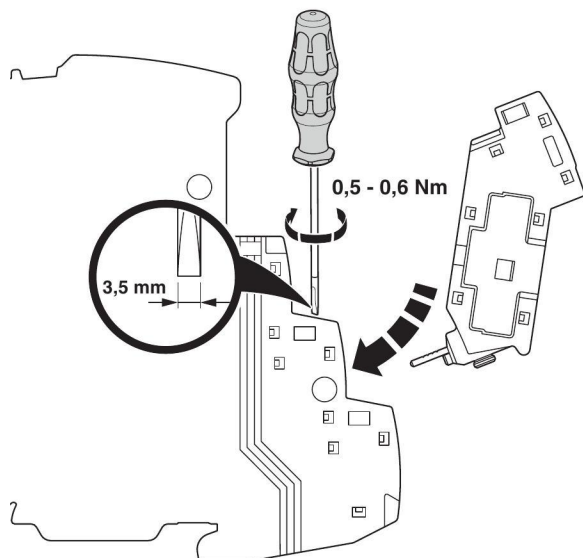

Figure 7 Fasten fuse carrier

- Place another fuse carrier at the next highest terminal level by rotating it slightly. Both fuse carriers must lock into each other.
- Screw on the fuse carrier.

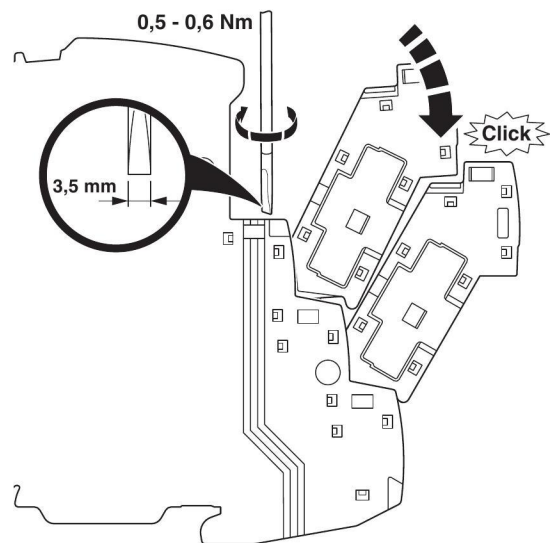

Figure 8 Fasten additional fuse carrier



Use the same cable cross-sections for the fuse carrier terminal connection as for the TERMITRAB complete module.

Note and observe the maximum values for power dissipation, current and voltage when using the fuse carrier.

## 6 Connection and operation

### 6.1 Safety notes

The installation and startup of this device may only be performed by an authorized (electrically) skilled person. The relevant country-specific regulations must be observed.



**WARNING: Risk of electric shock and fire**

Check the device for external damage. If the device is defective, it must not be used.



Ensure that the system's maximum operating voltage does not exceed the highest continuous  $U_C$  voltage.

Ensure that the maximum nominal current  $I_N$  of the overvoltage protection device is not exceeded during operation or in the event of a fault.

### 6.2 UL notes

#### 6.2.1 UL values (only valid for product in conjunction with UL 497B approval)

The approval is only valid for the pluggable products listed in file E138168.

	Nominal voltage	Nominal current	Nominal strike voltage	
			100 V/s (V DC)	100 V/μs (V DC)
TTC-6P-1X2-12DC	12 V DC	600 mA (40 °C)	15 ... 25 (L-L)	<1000 (L-L)
TTC-6P-1X2-(EX)-24DC	24 V DC	600 mA (40 °C)	30 ... 45 (L-L)	<1000 (L-L)
TTC-6P-1X2-48DC	48 V DC	160 mA	60 ... 80 (L-L)	<1000 (L-L)
TTC-6P-2-HC-24DC	24 V DC	6 A (40 °C)	30 ... 45 (L-L)	<1000 (L-L)
TTC-6P-2X1-12DC	12 V DC	600 mA (40 °C)	15 ... 25 (L-L)	<1000 (L-L)
TTC-6P-2X1-(EX)-24DC	24 V DC	600 mA (40 °C)	30 ... 45 (L-L)	<1000 (L-L)
TTC-6P-2X1-48DC	48 V DC	220 mA	60 ... 80 (L-L)	<1000 (L-L)
TTC-6P-2XTVSD-12DC	12 V DC	6 A (40 °C)	15 ... 25 (L-L)	<1000 (L-L)
TTC-6P-2XTVSD-24DC	24 V DC	6 A (40 °C)	30 ... 45 (L-L)	<1000 (L-L)
TTC-6P-3-5DC	5 V DC	6 A (40 °C)	5 ... 9 (L-L)	<1000 (L-L)
TTC-6P-3-(EX)-24DC	24 V DC	6 A (40 °C)	30 ... 45 (L-L)	<1000 (L-L)
TTC-6P-3-HF-(EX)-12DC	12 V DC	600 mA (40 °C)	15 ... 25 (L-L / L-G)	<1000 (L-L / L-G)
TTC-6P-3-HF-(EX)-24DC	24 V DC	600 mA (40 °C)	30 ... 45 (L-L / L-G)	<1000 (L-L / L-G)
TTC-6P-4-24DC	24 V DC	2,5 A (60 °C)	30 ... 55 (L-L)	<1000 (L-G)
TTC-6P-T3-24DC	24 V DC	6 A (30 °C)	35 ... 50 (L-L)	<1000 (L-L)

## 6.2.2 UL values (only valid for product with UL approval for potentially explosive areas; Class I Div. 2)

	Nominal voltage	Nominal current	Nominal strike voltage	
			100 V/s (V DC)	100 V/μs (V DC)
TTC-6P-1X2-M-EX-24DC-UT-I	24 V DC	600 mA (40 °C)	30 ... 45 (L-L)	<1000 (L-L)
TTC-6P-1X2-EX-24DC-UT-I				
TTC-6P-1X2-F-24DC-UT-I				
TTC-6P-1X2-F-24DC-PT-I				
TTC-6P-2X1-M-EX-24DC-UT-I	24 V DC	600 mA (40 °C)	30 ... 45 (L-G)	<1000 (L-G)
TTC-6P-2X1-F-24DC-UT-I				
TTC-6P-2X1-F-24DC-PT-I				
TTC-6P-3-HF-F-M-EX-12DC-UT-I	12 V DC	600 mA (40 °C)	15 ... 25 (L-L / L-G)	<1000 (L-L / L-G)
TTC-6P-3-HF-12DC-PT-I				
TTC-6P-3-HF-F-12DC-PT-I				
TTC-6P-3-HF-F-M-EX-24DC-UT-I	24 V DC	600 mA (40 °C)	30 ... 45 (L-L / L-G)	<1000 (L-L / L-G)
TTC-6P-3-EX-24DC-UT-I	24 V DC	6 A (40 °C)	30 ... 45 (L-L)	<1000 (L-L / L-G)
TTC-6P-3-24DC-UT-I				
TTC-6P-3-24DC-PT-I				
TTC-6P-3-5DC-PT-I	5 V DC	6 A (40 °C)	5 ... 9 (L-L)	<1000 (L-L / L-G)
TTC-6P-T3-24DC-UT-I	24 V DC	6 A (30 °C)	35 ... 50 (L-L)	<1000 (L-L / L-G)
TTC-6P-T3-24DC-PT-I				
TTC-6P-4-24DC-UT-I	24 V DC	2,5 A (60 °C)	30 ... 55 (L-L)	<1000 (L-G)
TTC-6P-4-24DC-PT-I				

	Nominal voltage	Nominal current	Nominal strike voltage	
			100 V/s (V DC)	100 V/μs (V DC)
TTC-6-2X1-24DC-UT	24 V DC	600 mA (40 °C)	30 ... 45 (L-L)	<1000 (L-L)
TTC-6-1X2-M-EX-24DC-UT-I				
TTC-6-2X1-24DC-UT	24 V DC	600 mA (40 °C)	30 ... 45 (L-G)	<1000 (L-G)
TTC-6-2X1-M-EX-24DC-UT-I				
TTC-6-3-HF-F-M-EX-12DC-UT-I	12 V DC	600 mA (40 °C)	15 ... 25 (L-L / L-G)	<1000 (L-L / L-G)
TTC-6-3-HF-12DC-PT				
TTC-6-3-HF-F-M-EX-24DC-UT-I	24 V DC	600 mA (40 °C)	30 ... 45 (L-L / L-G)	<1000 (L-L / L-G)



According to UL standard, the following is applies:

Suitable for use in class I, division 2, group A, B, C and D hazardous locations, or nonhazardous locations only



Do not disconnect equipment while the circuit is live or unless the area is known to be free of ignitable concentrations.

### 6.3 Installation and connection



Observe the necessary safety precautions when handling components that are vulnerable to electrostatic discharge (EN 61340-5-1 and IEC 61340-5-1).

TERMITRAB complete is designed for mounting on NS 35 DIN rails according to EN 60715.

To protect the device against mechanical or electrical damage, install it in a suitable housing with appropriate degree of protection as per IEC 60529.

#### Connecting cables

"Unprotected" and "protected" indicate the direction for installation of the protection modules.

- Connect the device upstream of the signal input to be protected. The imprint "unprotected" must point in the direction of the expected surge voltage. This is the direction of the incoming field cable.
- Connect the cables from the direction of the equipment to be protected to the terminal blocks marked "protected".
- Do not lay protected and unprotected cables directly next to each other over longer distances. This prevents surge voltages from being coupled into protected cables. Equipotential bonding lines are also considered unprotected cables.

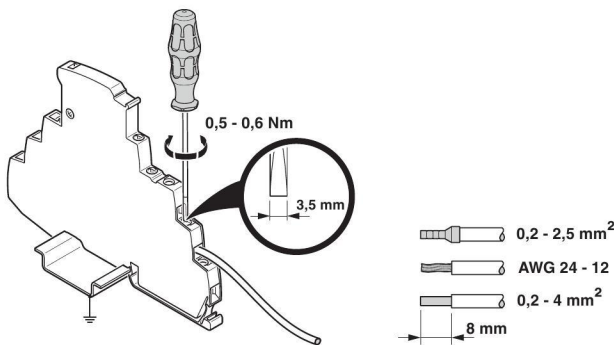

Figure 9 Connection version screw connection (overall width 6 mm)

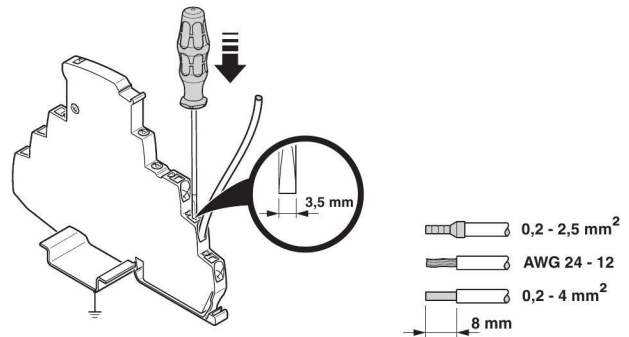

Figure 10 Connection version Push-in connection (overall width 6 mm)

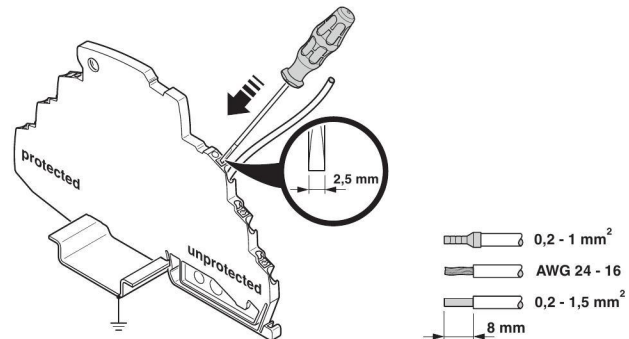

Figure 11 Connection version Push-in connection (overall width 3.5 mm)



The corresponding circuit diagrams can be found in the data sheet in the product area at [phoenixcontact.net/products](http://phoenixcontact.net/products).

#### Grounding

The device shows a current carrying capacity connection to the DIN rail.

Establish an electrical connection between DIN rail and ground potential. In this way transient overvoltage between signal wires and the ground are limited.

Products in core-core mode do not have a conductive connection to the DIN rail. These products are indicated with the letter "D" in the order key.

### Knife disconnection

Only for products with knife disconnection, which are indicated with the letter "M" in the order key.

To operate the disconnect knife, use a suitable bladed screwdriver of the size 0.6 x 3.5 mm.

- To open the contacts, turn the function screw 360° anti-clockwise. When open (unscrewed), the function screw of the knife disconnection is 7 mm above the upper edge of the housing. The function screw remains in the item socket.
- To close the contacts, turn the function screw 360° clockwise. In the end position, the function screw is flush with the upper edge of the housing.

### End cover

Products with an overall width of 3.5 mm and some versions with an overall width of 6 mm have an open housing side.

- Align these products side by side on the DIN rail.
- Use an end cover and suitable end bracket on the open side of the arranged products.



The corresponding end cover and the appropriate end brackets can be found in the accessories area for the relevant product at [phoenixcontact.net/products](https://phoenixcontact.net/products).

### Remote signaling set

Ensure the correct arrangement of the transmission module and receiver module.

- Connect the auxiliary power supply to the transmission module and receiver module.

The surge protection modules to be monitored require no additional power supply.

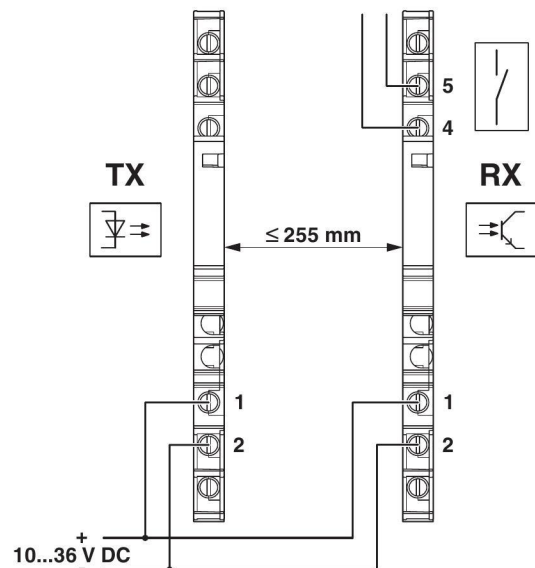

Figure 12 Remote signaling set connection



Further information is available in the operating instructions for electricians included with the remote signaling set.

### 6.4 Insulation testing

#### For products with knife disconnection

- Open the disconnect knife of the device before an isolation measurement. Otherwise, inaccurate measurements may occur.

#### For products without knife disconnection

- Disconnect the field cabling of the surge protective device before conducting insulation testing. Otherwise, inaccurate measurements may occur.
- Reconnect the cabling after insulation testing has been completed.

## 6.5 Testing option

### For products with screw connection technology

- Take measurements directly at the screw heads.

### For products with Push-in connection technology

- Take measurements at the additional test opening. These test openings can accommodate a probe tip that is 2 mm in diameter.

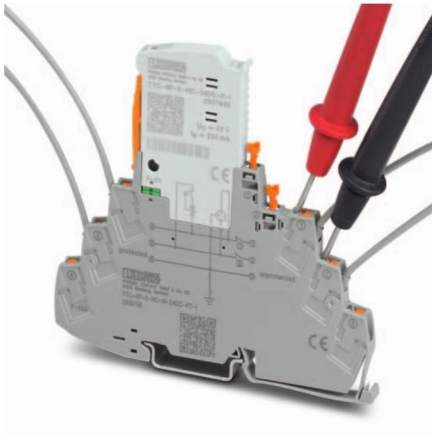

Figure 13 Measurement for Push-in connection technology

## 6.6 Marking

TERMITRAB complete offers the option of marking products for quick localization.

All TERMITRAB complete variants have zack marker strip grooves. Phoenix Contact offers marked and unmarked "ZBF" zack marker strips, which are suitable for series marking, for example.

Products with an overall width of 6 mm have a 6 x 15 mm area free on the visible side. This can be marked individually with a pen or label.

## 6.7 Removal from the DIN rail

To remove the device from the DIN rail, proceed as follows:

- Unlatch the base latch using a suitable screwdriver (blade width 3.5 mm). Lift the device slightly on the side of the base latch (A).
- Push the device to the other side of the DIN rail (B).

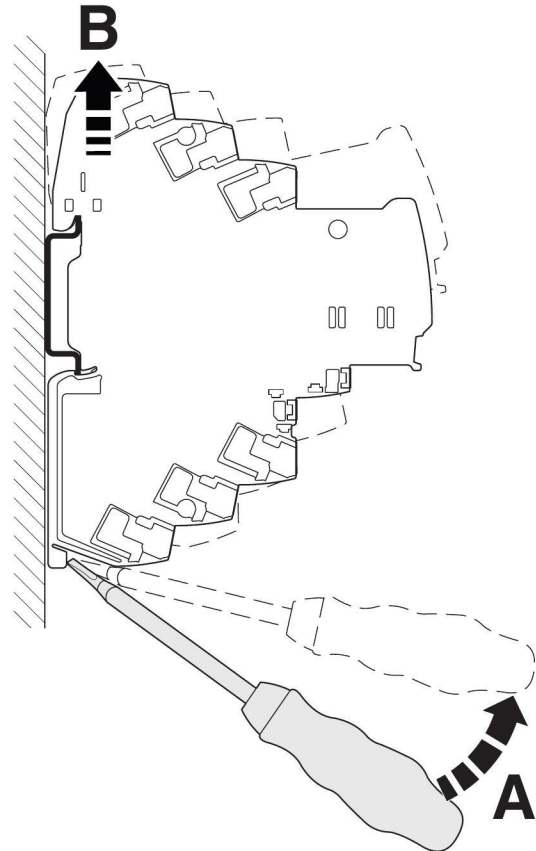

Figure 14 Removal from the DIN rail